

# THE TOOL TIMES®

Edition 7



## LET'S GET SERIOUS.

**BEST BUY**



~~€ 849,00~~  
**€ 769,00**

PAGE 43

**NEW**



~~€ 3,749.00~~  
**€ 3,189.00**

PAGE 11

# SERENCO

SERIOUS TOOLS SERIOUS RESULTS

**Welcome to our latest issue of Tool Times!  
Serenco has recently turned 35 years young and we are very proud of that.**

## **Serenco has been around for more than 35 years and that is not without reason:**

- Serenco is a leading supplier of professional tools and equipment
- For the car and bicycle industry but also in industry
- More than 2,500 high-quality items in stock
- Fast delivery from stock, to customers in no fewer than 48 countries
- All Serenco employees are knowledgeable, service-oriented and above all: proud!

**Serenco adds value by listening good to its customers, deliver innovative products and invest heavily in good service and aftersales.**

Serenco's range includes the brands BOXO (tools and workshop equipment), Powerhand (lamps and electrical tools), Power-Start (battery boosters), GoJak (vehicle movers), RakJak (air jacks), Bootgun (boot spreader), Metrinch (special tools), and Projecta (jump starters). All products are characterized by high quality and excellent practicality.

**LET'S  
GET  
SERIOUS.**

**SERENCO**  
SERIOUS TOOLS SERIOUS RESULTS



BOXO Tools, the choice for the professional. Grab an item from the BOXO range in your hands and you will feel it immediately. A quality product. Made to last indefinitely. For daily workshop and industrial use. The range of professional BOXO hand tools has expanded over the past decades and currently consists of more than 1,800 different items. Almost all items are also available separately, so in the event of a loss, you do not have to purchase a completely new set. Delivery is fast, because almost everything is in stock with us in Utrecht.

### Top chest with 4 drawers

AC7041M-G

- For use with AT7071M-G or stand alone
- Black + grey
- Foam mat worktop
- Foam capacity 4x 3
- Drawer capacity 45 kg
- With MIS-feature, only one drawer opens per time
- Lockable
- Size: (WxDxH) 677x459x439 mm
- Total weight capacity: 700 kg
- Weight: 34 kg



Foam 3/3

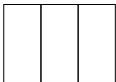

AC7041M-G

**€ 397.00**

~~€ 467.00~~

### Top chest with 4 drawers including 203 pc universal tool set

AC7041M-G+BXE017



### Top chest with 4 drawers including 233 pc universal tool set

AC7041M-G+BXE049



### Top chest with 4 drawers including 194 pc tool set for motorsport

AC7041M-G+BXE029



Check our website for the exact contents of the tool set:



AC7041M-G+BXE017

**€ 979.00**

~~€ 1,149.00~~

Check our website for the exact contents of the tool set:



AC7041M-G+BXE049

**€ 1,189.00**

~~€ 1,396.00~~

Check our website for the exact contents of the tool set:



AC7041M-G+BXE029

**€ 1,459.00**

~~€ 1,716.00~~

### Tool trolley with 7 drawers, Basic

BTD279071MP

- Black & grey
- Stainless steel worktop
- Foam capacity: 7x 3 foams
- Drawer capacity: 40 kg
- MIS-feature, only one drawer opens per time
- Lockable
- 4x 125 mm PP Casters (2 with brake)
- Size: (WxDxH) 678x459x1,000 mm
- Total weight capacity: 700 kg
- Weight: 51 kg



Foam 3/3

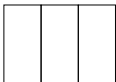

BTD279071MP

**€ 519.00**

~~€ 609.00~~

### Tool trolley including 203 pc universal tool set

BTD279071MP+BXE017

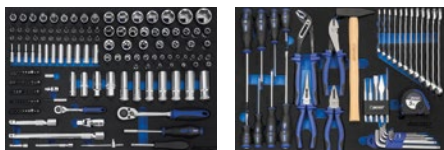

BTD279071MP+BXE017

**€ 1,099.00**

~~€ 1,291.00~~

Check our website for the exact contents of the tool set:



### Tool trolley including 233 pc universal tool set

BTD279071MP+BXE049

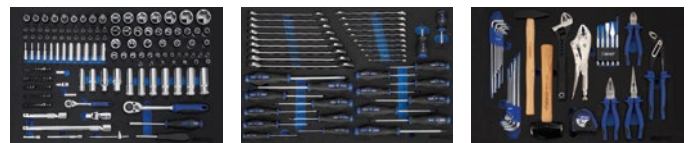

BTD279071MP+BXE049

**€ 1,309.00**

~~€ 1,538.00~~

Check our website for the exact contents of the tool set:



### Tool trolley including 330 pc mechanic tool set

BTD279071MP+BXE013

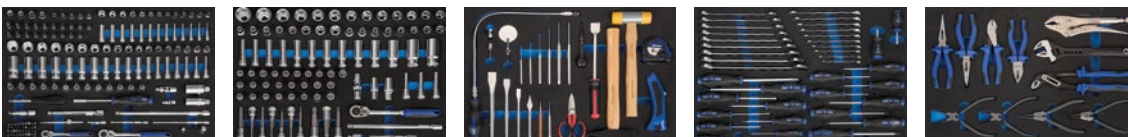

BTD279071MP+BXE013

**€ 1,809.00**

~~€ 2,124.00~~

Check our website for the exact contents of the tool set:





### Tool trolley with 7 drawers

AT7071M-G

- Black & grey
- Foam mat worktop
- Foam capacity: 7x 3 foams
- Drawer Capacity: 45 kg
- MIS-feature, only one drawer opens per time
- Lockable
- 4x 125 mm TPR casters (2 with brake)
- Size: (WxDxH) 681x459x1,000 mm
- Total weight capacity: 700 kg
- Weight: 61 kg
- Spray can holder
- Paper roll holder
- Drawer liners



Foam 3/3

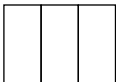

AT7071M-G

**€ 669.00**

~~€ 779.00~~

### Tool trolley including 203 pc universal tool set

AT7071M-G+BXE017

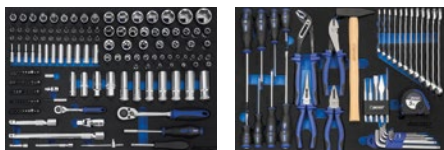

AT7071M-G+BXE017

**€ 1,249.00**

~~€ 1,461.00~~

Check our website for the exact contents of the tool set:



### Tool trolley including 233 pc universal tool set

AT7071M-G+BXE049

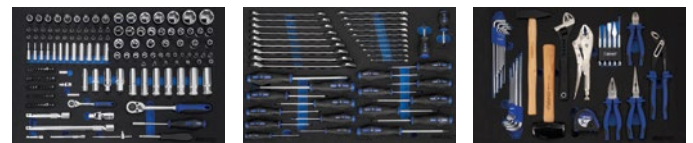

AT7071M-G+BXE049

**€ 1,449.00**

~~€ 1,708.00~~

Check our website for the exact contents of the tool set:



### Tool trolley including 330 pc mechanic tool set

AT7071M-G+BXE013

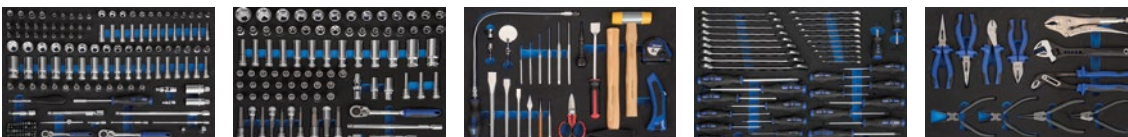

AT7071M-G+BXE013

**€ 1,949.00**

~~€ 2,294.00~~

Check our website for the exact contents of the tool set:



### Tool trolley XL with 7 drawers

MBT37071M-G

- Black & grey
- Stainless steel worktop
- Foam capacity: 7x 4 foams
- Drawer capacity: 45 kg
- With MIS-feature, only one drawer opens per time
- 4x 125 mm TPR casters (2 with brake)
- Lockable
- Size: (WxDxH) 915x495x1,000 mm
- Spray can holder
- Paper roll holder
- Drawer liners
- Total weight capacity: 700 kg
- Weight: 100 kg



Foam 4/4

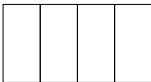

MBT37071M-G

**€ 979.00**

~~€ 1,149.00~~

### Tool trolley XL with 7 drawers including 410 pc mechanic tool set

MBT37071M-G+BXE032

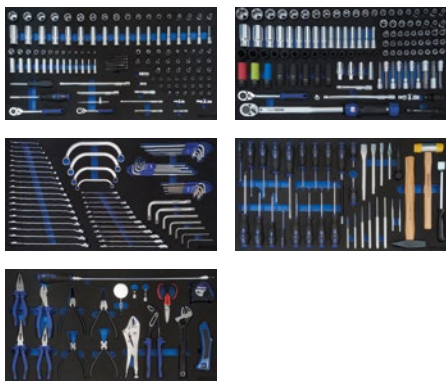

Check our website for the exact contents of the tool set:



MBT37071M-G+BXE032

**€ 2,717.00**

~~€ 3,198.00~~

### Tool trolley XL with 7 drawers including 538 pc mechanic tool set

MBT37071M-G+BXE030

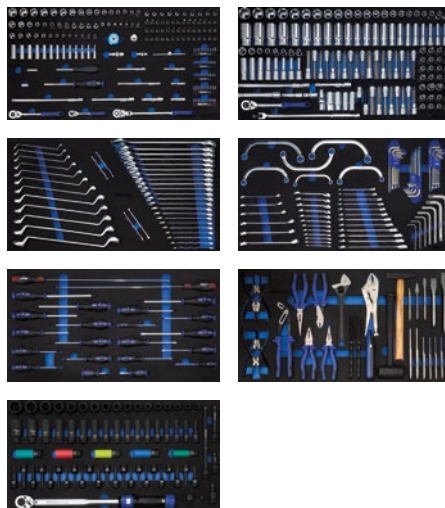

Check our website for the exact contents of the tool set:



MBT37071M-G+BXE030

**€ 3,679.00**

~~€ 4,328.00~~

### Tool trolley XL with 7 drawers including 305 pc HD tool set

MBT37071M-G+BXE033



Check our website for the exact contents of the tool set:



MBT37071M-G+BXE033

**€ 3,119.00**

~~€ 3,674.00~~



### Tool trolley XL with 8 drawers

MBT37081M-G

**BEST BUY**

- Black & grey
- Stainless steel worktop
- Foam capacity: 7x 4 foams
- Drawer capacity: 45 kg
- MIS-feature, only one drawer opens per time
- 4x 125 mm TPR heavy duty casters (2 with brake)
- Lockable
- Size: (WxDxH) 915x459x1,000 mm
- Spray can holder
- Paper roll holder
- Drawer liners
- Total weight capacity: 700 kg
- Weight: 102 kg



Foam 4/4

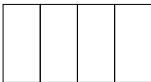

MBT37081M-G

**€ 1,019.00**

~~€ 1,199.00~~

### Tool trolley XL with 8 drawers including 410 pc mechanic tool set

MBT37081M-G+BXE032

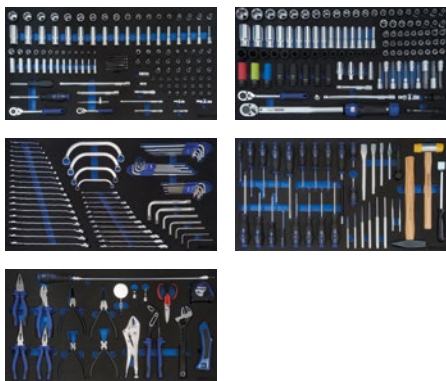

Check our website for the exact contents of the tool set:



MBT37081M-G+BXE032

**€ 2,759.00**

~~€ 3,248.00~~

### Tool trolley XL with 8 drawers including 538 pc mechanic tool set

MBT37081M-G+BXE030

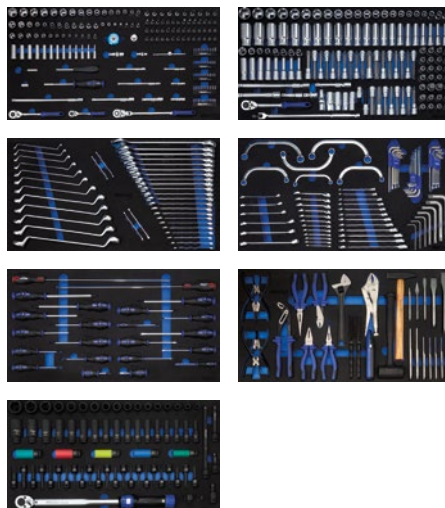

Check our website for the exact contents of the tool set:



MBT37081M-G+BXE030

**€ 3,719.00**

~~€ 4,378.00~~

### Tool trolley XL with 8 drawers including 619 pc mechanic tool set

MBT37081M-G+BXE031

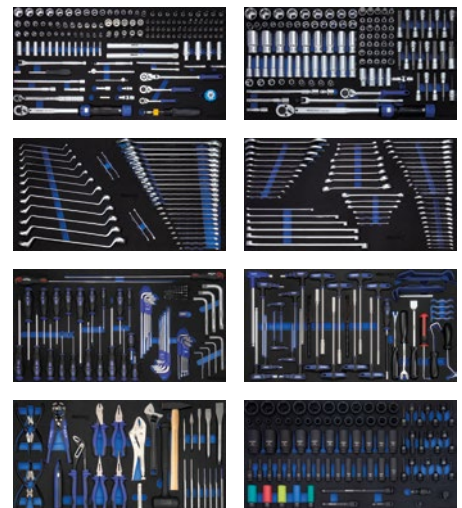

Check our website for the exact contents of the tool set:



MBT37081M-G+BXE031

**€ 4,839.00**

~~€ 5,698.00~~

**Tool trolley 11 drawers black/grey**  
**MBT530111M-G**

- Black & grey
- Stainless steel worktop
- Foam capacity: 5x 4, 5x 2 and 1x 6
- Drawer capacity: 45 kg
- MIS-feature, only one drawer opens per time
- 4x 125 mm TPR casters (2 with brake)
- Lockable
- Size: (WxDxH) 1,354x459x1,008 mm
- Spray can holder
- Paper roll holder
- Drawer liners
- Total weight capacity: 700 kg
- Weight: 150 kg

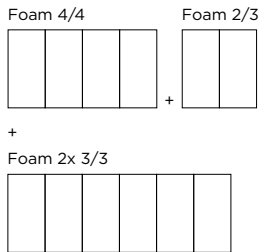

MBT530111M-G

**€ 2,099.00**    ~~€ 2,469.00~~





### Tool trolley XXXL with 14 drawers

MBT530141M-G

- Black & grey
- Stainless steel worktop
- Foam capacity: 7x 4 + 7x 2
- Drawer capacity: 45 kg
- MIS-feature, only one drawer opens per time
- 4x 125 mm TPR casters (2 with brake)
- Lockable
- Size: (WxDxH) 1,354x459x1,008 mm
- Spray can holder
- Paper roll holder
- Drawer liners
- Total weight capacity: 700 kg
- Weight: 150 kg

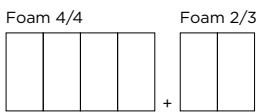

MBT530141M-G

**€ 1,929.00**

~~€ 2,269.00~~

### Tool trolley XXXL with 14 drawers including 410 pc heavy duty truck tool set

MBT530141M-G+BXE032



MBT530141M-G+BXE032

**€ 3,669.00**

~~€ 4,318.00~~

Check our website for the exact contents of the tool set:



### Tool trolley XXXL with 14 drawers including 305 pc heavy duty truck tool set

MBT530141M-G+BXE033



MBT530141M-G+BXE033

**€ 4,069.00**

~~€ 4,794.00~~

Check our website for the exact contents of the tool set:



### Tool trolley XXXL with 12 drawers

ATR450131CL-GW

- Black + grey
- Rubberwood worktop
- Foam capacity: 7x 3 + 5x 3
- Drawer capacity: 45 kg
- MIS-feature, only one drawer opens per time
- Size: (WxDxH) 1,160x716x1,000 mm
- 4x 125 mm PU casters (2 with brake)
- Lockable
- Spray can holder
- Paper roll holder
- Drawer liners
- Total weight capacity: 1,000 kg
- Weight: 160 kg



ATR450131CL-GW

**€ 2,039.00** ~~€ 2,399.00~~

### Tool trolley with 12 drawers and wooden top including 233 pc universal tool set

ATR450131CL-GW+BXE049

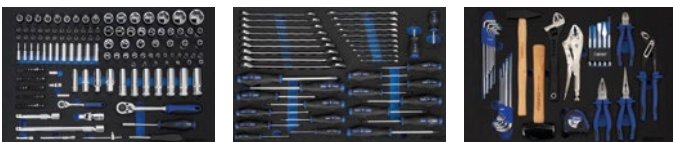

ATR450131CL-GW+BXE049

**€ 2,829.00** ~~€ 3,328.00~~

Check our website for the exact contents of the tool set:



### Tool trolley with 12 drawers and wooden top including 330 pc mechanic tool set

ATR450131CL-GW+BXE013

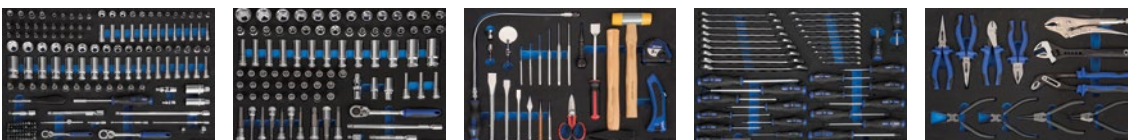

ATR450131CL-GW+BXE013

**€ 3,329.00** ~~€ 3,914.00~~

Check our website for the exact contents of the tool set:





### Tool trolley 4XL with 19 drawers

UAT720191-BK

- Black + grey
- Stainless steel worktop
- Foam capacity: 11x 2, 5x 4 and 3x 6
- Top drawer capacity 120 kg
- Rest of the drawers capacity 60 kg
- Latching handles on all drawers, keep drawers closed when on the move
- Size: (WxDxH) 1,915x610x1,240 mm
- Lockable
- Aluminum grip drawer handles
- Heavy duty swivel-casters 200 mm
- Drawer liners
- Total weight capacity: 1,500 kg
- Weight: 330 kg

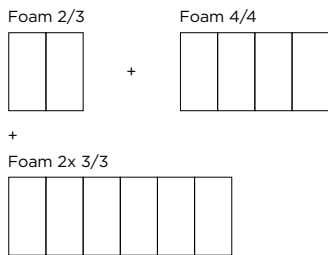

UAT720191-BK

**€ 3,189.00**

~~€ 3,749.00~~

**NEW**  
Personalise your tool trolley with your own colour!

Check our website for the exact contents of the tool set:



### Tool trolley 4XL black/blue

UAT720191-BKB



UAT720191-BKB

**€ 3,189.00**

~~€ 3,749.00~~

### Tool trolley 4XL black/red

UAT720191-BR



UAT720191-BR

**€ 3,189.00**

~~€ 3,749.00~~

### Tool trolley 4XL black/silver

UAT720191-BS



UAT720191-BS

**€ 3,189.00**

~~€ 3,749.00~~

### Tool trolley 4XL white/blue

UAT720191-WB



UAT720191-WB

**€ 3,189.00**

~~€ 3,749.00~~

### Tool trolley 4XL white/red

UAT720191-WR



UAT720191-WR

**€ 3,189.00**

~~€ 3,749.00~~

### Tool trolley 4XL white/silver

UAT720191-WS



UAT720191-WS

**€ 3,189.00**

~~€ 3,749.00~~

### Multi functional cabinet with backpanels + power unit

MST342021P+MSN004-230V

- Black + grey
- Stainless steel worktop
- Foam capacity: 2x 2
- Drawer capacity: 50 kg
- MIS-feature, only one drawer opens per time
- Size: (WxDxH) 861x500x1,940 mm
- Auto return ball bearing slides
- 4x 100 mm rubber casters (4 swivel & 2 with brake)
- 1 drawer 378x397x75 mm
- 1 drawer 378x397x154 mm
- 2x 230 V - 2x USB

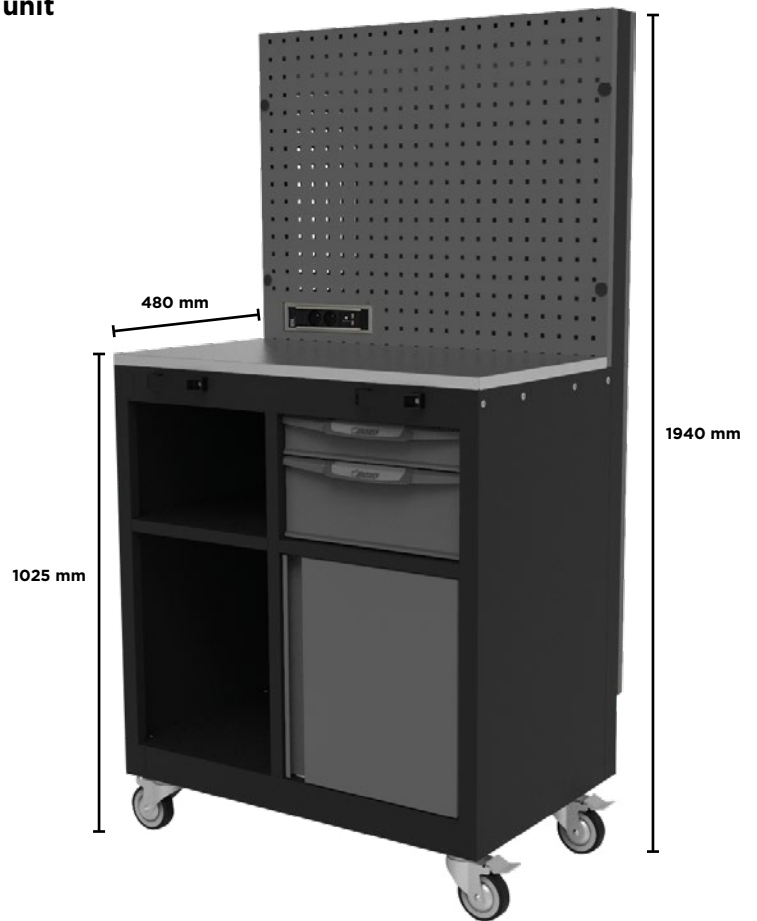

Foam 2/3



MST342021P+MSN004-230V

**€ 1,299.00**

~~€ 1,525.00~~

### Heavy duty service cart, 3 tray

BSD-283000-BG

- Black & grey
- Powder-coated, scratch and solvent resistant finish
- High performance casters with brake system  
4x 50 mm PO casters
- 3 trays, capacity 50 kg each
- Tray size: 700x385 mm



BSD-283000-BG

**€ 189.00**

~~€ 229.00~~

### Universal diagnose trolley with 2 drawers

ECC22041

- Steel worktop
- Hanging hook: 2 pc
- Lockable
- Perforated side walls
- Storage compartment: (WxDxH) 480x258x330 mm
- Storage compartment capacity: 15 kg
- Drawer capacity: 30 kg
- Bottom shelf capacity: 150 kg
- 4x 100 mm PU casters (2 swivel casters with brake)

YouTube



ECC22041

**€ 489.00**

~~€ 575.00~~



### Carry box, 3 drawers including 103 pc tool set (MOTORBIKE)

ECC20301BK-103

- Safety-insert-system: all tools are securely embedded, missing tools are noticed immediately
- Auto returning ball bearing slider for smooth opening and closing
- Complete with 103 pc assortment
- Lockable
- Weight: 22 kg
- Size: (WxDxH) 521x256x300 mm

Contents of this 103 pc tool set:

- 63 pc 1/4" & 3/8" Socket set
- 15 pc Tools set
- 6 pc Pliers set
- 19 pc Wrench + tire gauge set



Check our website for the exact contents of the tool set:



ECC20301BK-103

**€ 919.00**

~~€ 1,079.00~~

### Carry box, 3 drawers and 57 pc tool set (KARTING & MOTORCROSS)

ECC20301KART

- Safety-insert system: all tools are securely embedded, missing tools are noticed immediately
- Auto returning ball bearing slider for smooth opening and closing
- Lockable
- Size: (WxDxH) 521x256x300 mm
- Weight: 21 kg



Check our website for the exact contents of the tool set:



ECC20301KART

**€ 619.00**

~~€ 729.00~~

### Carry box, 3 drawers including 94 pc tool set (UNIVERSAL)

ECC20301BK

- Safety-insert system: all tools are securely embedded, missing tools are noticed immediately
- Auto returning ball bearing slider for smooth opening and closing
- Lockable
- Size: (WxDxH) 521x256x300 mm
- Weight: 21 kg

**BEST BUY**



Check our website for the exact contents of the tool set:



ECC20301BK

**€ 484.00**

~~€ 569.00~~



**Tool set, 57 pieces in strong rol bag**  
PA902

**NO NOISE POUCH**

- Size closed: 44.5x19x10 cm
- Size open: 75x44.5x2.5 cm
- No noise rol bag
- Ideal for service vehicles

- Contents:
- 9 - 19 mm
  - Ratchet 90T 1/4" and 1/2"



Check our website for the exact contents of the tool set:



PA902

**€ 295.00** ~~€ 345.00~~

**Socket set, 21 pieces 3/4", large sizes**  
BxB013

- Contents:
- Sockets: 19, 21, 22, 23, 24, 26, 27, 29, 30, 32, 35, 36, 38, 41, 46, 50 mm
  - Extension bar: 100, 200, 410 mm
  - 2-in-1 ratchet handle
  - Sliding T-handle 450 mm



BxB013

**€ 294.00** ~~€ 345.00~~

**Socket set, 72 pieces, 1/4"**  
BX037-BC

- 1/4" Sockets and deep sockets 4 - 14 mm
- 72 Teeth ratchet
- 1/4" Bit sockets, 36 pc
- Supplied in a HD BMC for daily use
- Safety insert system: all tools are securely embedded, missing tools are noticed immediately



BX037-BC

**€ 109.00** ~~€ 128.95~~

**Socket set, 32 pieces, 3/8"**  
BX378-BC

- 3/8" Sockets 7 - 24 mm
- 72 Teeth ratchet
- Spark plug sockets 14, 16, 18, 21 mm
- Supplied in a HD BMC for daily use
- Safety insert system: all tools are securely embedded, missing tools are noticed immediately



BX378-BC

**€ 104.00** ~~€ 121.25~~

**Socket set, 27 pieces, 1/2"**  
BX367-BC

- 1/2" Sockets 8 - 32 mm
- 72 Teeth ratchet
- Breaker bar 375 mm
- Supplied in a HD BMC for daily use
- Safety insert system: all tools are securely embedded, missing tools are noticed immediately



BX367-BC

**€ 117.00** ~~€ 137.00~~

### Hand impact driver set in foam 3/8", 10 pc

BX523

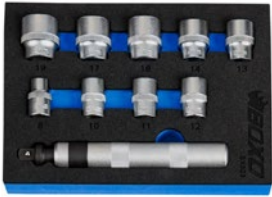

- Foam size: 1/4
- Impact driver 146 mm
- Sockets: 8, 10, 11, 12, 13, 14, 16, 17, 19 mm

BX523

€ 52.25

~~€ 61.50~~

### Open-end spanner set in foam, ultra thin, 7 pc

BX391-2



- Foam size: 1/3
- Length: 6x7 mm: 149 mm  
8x9 mm: 178 mm  
10x11 mm: 177 mm  
12x13 mm: 211 mm  
14x15 mm: 211 mm  
16x17 mm: 250 mm  
18x19 mm: 251 mm
- Thickness: 2 - 4.5 mm

BX391-2

€ 63.50

~~€ 74.50~~

### Drain plug key set in foam, 17 pc

VVE034

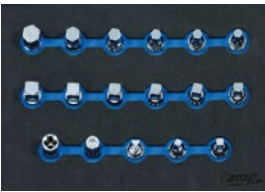

- Foam size: 1/4
- Includes: Triangle 10 mm SX10
- Square: 7, 8, 10, 11, 12, 13, 14 mm
- Square: 3/8" M16
- Hex: 8, 9, 10, 12, 14, 17 mm

VVE034

€ 56.00

~~€ 65.75~~

### System release tool set in foam, 23pc

VVD005

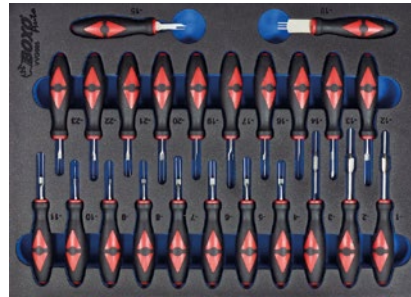

- Foam size: 1/2
- Designed specifically for removing plug type connectors, quickly repair faults and corrosion
- Universal application

VVD005

€ 183.00

~~€ 215.00~~

### Air impact wrench set, incl. torque wrench 1/2", 37 pc

BX390



- Foam size: 3/3
- 1/2" Composite air impact wrench, 1111 Nm
- 1/2" Torque Wrench 40-200 Nm
- 1/2" Swivel handle 460 mm
- Torque E-Bars 90 Nm (green), 100 Nm (black), 110 Nm (yellow), 120 Nm (red), 135 Nm (blue)
- 46 cm Go through pry bar
- Impacts sockets 8, 9, 10, 11, 12, 13, 14, 15, 16, 17, 18, 19, 20, 21, 22, 23, 24 mm
- Wheel impact socket 17, 19, 21, 22 mm
- Extension 125 mm

BX390

€ 609.00

~~€ 713.00~~

**BEST BUY**

Check our website for the exact contents of the tool set:



**Brake caliper rewind kit in foam, 18 pc**  
VVB001

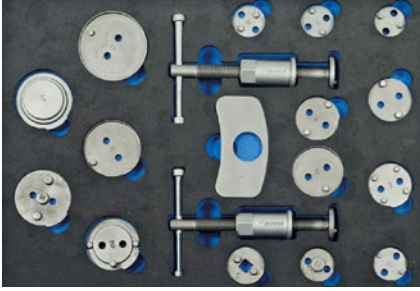

- Foam size: 1/2
- Winds back brake piston for replacing brake pads
- Suitable for right or left-handed use
- Helps to prevent damage to pistons and seals
- Suitable for a wide variety of vehicle applications including Audi, BMW, Ford, Toyota, VAG etc.

Contents:

- Left-handed T-bar
- Right-handed T-bar
- 15x adaptors

VVB001

**€ 98.00**

~~€ 115.25~~

**Brake bleeder set, vacuum, 3 pc**  
VVB005



- Suitable for anti-lock brake systems
- Integrated Venturi-system creates a vacuum with standard workshop air supply
- Universal plastic nozzle for all common vehicle types
- Clear transparent brake fluid hose for visibility
- Removes fluid via bleed nipples for bleeding or entire fluid replacement

Contents:

- 1 liter brake fluid bottle with fixed nozzle, 1 liter brake fluid bottle with flexible nozzle, 1 liter vacuum brake bleeder.

VVB005

**€ 74.50**

~~€ 87.50~~

**RIBE bit socket set 1/2" 32 pc**  
VVE054

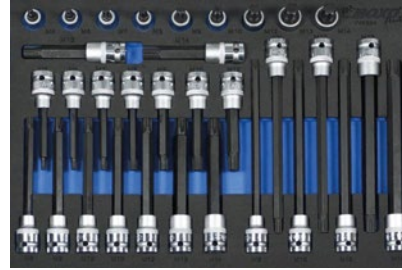

- Foam size: 1/2
- Sizes: M5, M6, M7, M8, M9, M10, M12, M13, M14
- Lengths: 55, 100, 140, 200 mm

VVE054

**€ 136.95**

~~€ 161.00~~

**Petrol cylinder compression tester**  
VVE044



- Foam size: 1/2
- Stem with release valve and quick release chuck for attaching fittings
- Displays in psi/bar: (0 - 300 psi) (0 - 20 bar)
- Suitable adapters: M10, M12, M14, M18

VVE044

**€ 95.25**

~~€ 112.00~~

**3 way T-Handle hex key set H2 - H10, 9-pc**  
BX699

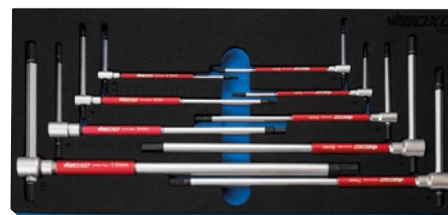

- 2, 2.5, 3, 4, 5, 6, 7, 8, 10 mm

BX699

**€ 91.00**

~~€ 107.00~~



**VDE Socket set in box 10-32 mm, 20 pc**  
BXI-SO20



- VDE 1000 V 1/2" Reversible ratchet
- VDE 1000 V 1/2" Extension bars 125, 250 mm
- VDE 1000 V 1/2" Sliding T-bar
- VDE 1000 V 1/2" Sockets: 10, 11, 12, 13, 14, 17, 19, 22, 24, 27, 32 mm
- VDE 1000 V 1/2" Hex bit sockets 4, 5, 6, 8, 10 mm

BXI-SO20

**€ 379.00** ~~€ 449.00~~

**Wrench extensioner**  
VG513



- Ideal tool for extending your wrenches/spanners
- Max. Suitable wrench: 27mm
- Length: 340mm
- 1/2" square hole, suitable for a ratchet

VG513

**€ 37.95** ~~€ 44.50~~

**1/4" Torque wrench 5-25 Nm**  
TW266-2M



- 5 - 25 Nm - 1/4" - 64T

TW266-2M

**€ 119.00** ~~€ 139.50~~

**1/2" SAE deep socket set, 14 pc**  
BX684-2



- 1/2" SAE 6PT: 3/8", 7/16", 1/2", 9/16", 5/8", 11/16", 3/4", 13/16", 7/8", 15/16", 1", 1-1/16", 1-3/16", 1-1/4"

BX684-2

**€ 61.00** ~~€ 71.95~~

**Long reach ratchet set in foam 36t, 3 pc**  
BX431-2



- 1/4" - 72T - 229 mm
- 3/8" - 72T - 407 mm
- 1/2" - 72T - 560 mm

BX431-2

**€ 130.95** ~~€ 154.00~~

**Tester 12V-690 V**  
SCWT-L690V



- Can test an entire circuit from the battery to the component in question
- Determine if the relay itself is functioning properly
- Instantly determine the problem within the circuit
- No need of a multimeter: just push the button

SCWT-L690V

**€ 79.50** ~~€ 93.25~~

**Go through Pry Bar**  
VG506-SERIE



- Ergonomic comfort-grip handle
- Ideal for a range of automotive applications
- 6.35 x 200 mm
- 9.5 x 300 mm
- 11 x 450 mm
- 11 x 600 mm

€ 8.95	<del>€ 10.50</del>	200 mm	VG506-1
€ 12.00	<del>€ 14.15</del>	300 mm	VG506-2
€ 16.75	<del>€ 19.50</del>	450 mm	VG506-3
€ 19.15	<del>€ 22.50</del>	600 mm	VG506-4

Starting from

**€ 8.95**

### Waterpump pliers

€ 22.75	<del>€ 26.75</del>	165 mm	U-PR9540-165
€ 27.25	<del>€ 31.95</del>	200 mm	U-PR9540-203
€ 32.25	<del>€ 37.75</del>	245 mm	U-PR9540-241
€ 28.50	<del>€ 33.50</del>	250 mm	U-PR9540-254
€ 32.50	<del>€ 38.25</del>	300 mm	U-PR9540-305
€ 53.50	<del>€ 62.75</del>	420 mm	U-PR9540-419
€ 106.00	<del>€ 124.50</del>	510 mm	U-PR9540-514

Starting from

**€ 22.75**



- High-carbon C1080 steel for superior performance on the job and electronic coating for ultimate rust prevention
- Patented reinforcing edge minimizes stress breakage
- Undercut tongue & groove design won't slip
- Right-angle, laser-heat treated teeth grip better and last longer
- PermaLock® fastener eliminates nut and bolt failure

### Oilfilter removal pliers

U-PR9110-SERIE

- High-carbon C1080 steel for superior performance on the job and electronic coating for ultimate rust prevention
- Patented reinforcing edge minimizes stress breakage
- Undercut tongue & groove design won't slip
- Right-angle, laser-heat treated teeth grip better and last longer
- PermaLock® fastener eliminates nut and bolt failure
- Capacity: 44/89 mm and 70/108 mm

€ 31.00	<del>€ 36.50</del>	225 mm	U-PR9110-228
€ 42.00	<del>€ 49.50</del>	300 mm	U-PR9110-305

Starting from

**€ 31.00**



### Diagonal cutter 240 mm

U-PR9550-242

- Box joint diagonal Laser heat-treated cutting edges last longer
- Boxo uses a knife and anvil style cutting edge to ensure perfect mating and superior cutting edge life
- Boxo uses a high-carbon C1080 steel for superior performance on the job and electronic coating for ultimate rust prevention

U-PR9550-242

**€ 49.95**

~~€ 58.50~~



### Long reach plier with flat nose 200 mm

U-PR9521-200

- Long reach plier with flat nose 200 mm
- Flat nose Crosshatch teeth pattern
- Designed for long reach applications and hard to reach spaces
- Boxo uses high-carbon C1080 steel for superior performance on the job and electronic coating for ultimate rust prevention

U-PR9521-200

**€ 33.50**

~~€ 39.25~~



### Nut buser grip pliers 245 mm

U-PR9541-241

- Unique SAFE-T-STOP® feature prevents finger pinch
- Boxo uses high-carbon C1080 steel for superior performance on the job and electronic coating for ultimate rust prevention
- Parrot Nose design ideal for round surfaces
- Unique double tongue & groove design won't slip
- PermaLock® fastener eliminates nut and bolt failures
- Capacity: 0 to 28.5 mm

U-PR9541-241

**€ 31.50**

~~€ 36.95~~



## Digital angled torque wrench, 3/8" and 1/2"

TWD3-B01 / TWD4-B01

**NEW**



3/8"

- 8.8 - 135 Nm
- Angle settings: 1 - 360%
- Length: 434 mm
- Weight: 0.85 kg
- 72 teeth
- Calibrated: 1.5% - 2.5% tolerance
- Memory function: 30 pre-settings

1/2"

- 17 - 340 Nm
- Angle settings: 1 - 360%
- Length: 666 mm
- Weight: 1.37 kg
- 72 teeth
- Calibrated: 1.5% - 2.5% tolerance
- Memory function: 30 pre-settings

Check our website for all specifications



Check our website for all specifications



TWD3-B01 ~~€ 389.00~~ TWD4-B01 ~~€ 464.00~~

**€ 329.00 / € 395.00**

## Dead blow hammer

HM7850-SERIE



€ 21.00	<del>€ 24.75</del>	260 mm, 400 gr	HM7850-035
€ 24.00	<del>€ 28.25</del>	286 mm, 520 gr	HM7850-045
€ 27.75	<del>€ 32.50</del>	350 mm, 1,050 gr	HM7850-055
€ 36.50	<del>€ 42.95</del>	370 mm, 1,500 gr	HM7850-065

Starting from

**€ 21.00**

## 1/2" Impact wrench

NI3676

- 1/2" Composite impact wrench
- Weight: 1.65 kg
- Work torque: 2,100 Nm
- Noise level: 91.5 dB
- Length: 159 mm



NI3676

**€ 202.00**

~~€ 237.00~~

## Calibrated ratcheting torque wrenches

TWM2-SERIE

- Calibrated 3% tolerance



€ 124.95	<del>€ 147.00</del>	12 - 60 Nm - 3/8" - 24T	TWM2-60N
€ 131.50	<del>€ 154.50</del>	20 - 100 Nm - 3/8" - 24T	TWM2-100N
€ 135.50	<del>€ 159.00</del>	40 - 200 Nm - 1/2" - 24T	TWM2-200N
€ 177.75	<del>€ 209.00</del>	60 - 320 Nm - 1/2" - 24T	TWM2-320N
€ 552.00	<del>€ 649.00</del>	150 - 800 Nm - 3/4" - 36T	TWM2-800N
€ 669.00	<del>€ 789.00</del>	200 - 1,000 Nm - 1" - 36T	TWM2-1000N
€ 1,089.00	<del>€ 1,279.00</del>	300 - 1,500 Nm - 1" - 36T	TWM2-1500N

Starting from

**€ 109.00**

## Mechanics mat, 4 sizes

B-M-SERIE

**BEST BUY**

- Full-length mechanics mat  
XL: 1,130x455x30 mm



€ 16.75	<del>€ 19.50</del>	270x460x30 mm	B-M0460
€ 18.95	<del>€ 22.25</del>	320x480x30 mm	B-M0480
€ 30.25	<del>€ 35.50</del>	380x900x30 mm	B-M0900
€ 49.75	<del>€ 58.50</del>	455x1130x30 mm	B-M1130

Starting from

**€ 16.75**



# BOXO OSM



BOXO, the name for quality tool storage systems developed for the professional automotive and industrial markets. Benefitting from over 40 years of experience in these industries manufacturing high quality tool storage systems. We focus on product research, design, durability, quality control with a real life testing facility. The creators of BOXO have developed this program of tool storage systems to suit all modern day requirements. BOXO continually works on product and service improvement. All BOXO products have been manufactured to meet or exceed international standards.



## OSM modular workshopstation

OSM-24247

- Multi-functional cabinet, suitable for paper roll, rubbish bin, each drawer can hold 50 kg
- Cabinet with 2 drawers, one drawer can hold 90 kg
- Double cabinet with 10 drawers, top drawer can hold 120 kg, second drawer can hold 90 kg, normal drawers can hold 50 kg, 1,636 mm tools fit in the top drawers
- 2 Times power outlet, 2x 230 V & 2x USB
- Perforated back panels, to store tools
- 2 Cupboards with gas struts
- Rubberwood worktop 40 mm thick, 500 mm deep
- Adjustable feet
- One key system



OSM-24247

€ 5,949.00

~~€ 6,609.90~~

## OSM modular workshopstation

OSM-24248

- 2 High cabinets with adjustable shelves, each shelf can hold 20 kg
- Cabinet with 3 drawers and door, each drawer which can hold 50 kg
- Cabinet with 2 doors, 1 shelf, each shelf can hold 25 kg
- 7 Drawer trolley, each drawers can hold 45 kg
- Power outlet, 2x 230 V & 2x USB
- Perforated back panels, to store tools
- 3 Cupboards with gas struts
- Multiplex worktop 40 mm thick, 500 mm deep
- Adjustable feet
- One key system



OSM-24248

**€ 5,299.00**

~~€ 5,897.05~~

### OSM modular workshopstation

OSM-24249

- Double multi-functional cabinet, suitable for paper roll, rubbish bin, each drawer can hold 50 kg
- 2x cabinet with 4 drawers, each drawer can hold 50 kg
- 2 x power outlet, 2x 230 V & 2x USB
- Closed back panels, to keep tools from falling of the workstation
- 2x stainless steel worktop 40 mm thick, 500 mm deep
- Dust cover on the top
- Adjustable feet
- One key system



OSM-24249

€ 5,199.00

~~€ 5,770.30~~



**OSM modular worksatation, 700 mm worktop**

OSM-24250

- High cabinet with adjustable shelves, each shelf can hold 20 kg
- Cabinet with 2 drawers, one drawer can hold 90 kg
- Cabinet with 5 drawers, each drawer can hold 50 kg
- Cabinet with 9 drawers, each drawer can hold 50 kg
- Multiplex worktop 40 mm thick, 700 mm deep
- Perforated back panels, to store tools
- Wall storage system with "Tambour" roller shutter door, to keep expensive tools save
- Adjustable feet
- One key system



OSM-24250

**€ 5,199.00**

~~€ 5,786.05~~

### Cabinet with 7 drawers, available colours OSM:

MST340071-RBKR/ MST340071-RBKB/  
MST340071-RBK/ MST340071-BKBK

- Powder coating to resist scratch and solvent markings
- Auto returning ball bearing slider for smooth opening and closing
- Drawer capacity: 50 kgs per drawer
- Aluminium drawer handles
- Adjustable leveling feet
- Lockable
- Standard 'one key system'

#### Dimensions:

- Overall (WxDxH) 861x500x953 - 1,004 mm
- 5 Drawer (WxDxH) 753x397x75 mm
- 2 Drawer (WxDxH) 753x397x154 mm
- Usable height inside drawer:
  - 5 Drawer 53 mm
  - 2 Drawer 139 mm



MST340071-RBKR



MST340071-RBKB



MST340071-RBK



MST340071-BKBK

**NEW**  
Personalise your  
OSM-Racing  
set-up with your  
own colour!

€ 819.00

~~€ 959.00~~



### Pharmacy cabinet 700 mm deep

MSTD44201

- Ideal for storing special tools in a limited space
- Doors open 180°
- Weight per pegboard 75 kg (one side), 150 kg per slider (two sides)
- Adjustable levelling feet
- Lock and key
- Overall dimension: (WxDxH) 1,121x700x1,980 mm
- Hooks not included.

MSTD44201

€ 2,419.00

~~€ 2,849.00~~

### Oil cabinet 700 mm deep

MSTD44101

- With adjustable shelf 2 pc, loading capacity max. 80 kg
- With adjustable leveling feet
- Door with perforated holes
- With 1 pc support bracket (screw by knob)
- With lock & key set
- Dimension (including the adjustable feet): overall: (WxDxH) 1,221x700x1,982.3 mm

#### Oil Container

- Steel container (painting) contents 66 L
- With RVS grating on top
- With adjustable leveling feet
- Dimension (including the adjustable feet): overall: (WxDxH) 900x500x262.7 mm



MSTD44101

**€ 1,487.00**

~~€ 1,749.00~~

### OSM on wheels

OSM-21481

- Rubberwood worktop 40 mm thick, 500 mm deep
- Top drawer capacity 120 kg per drawer
- Drawer capacity 60 kg per drawer
- TPR soft grip drawer handles
- Drawer liners
- Overall size: (WxDxH) 1,722x500x954 mm (without mobile frame)



P-MST-13

**OSM mobile base,  
suitable for all  
OSM cabinets**

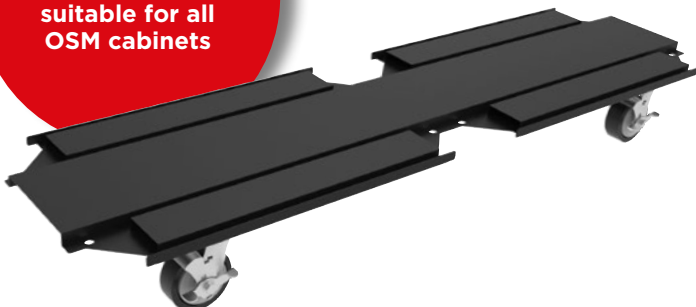

OSM-21481

**€ 2,249.00**

~~€ 2,625.00~~





**CONFIGURE  
YOUR OWN WORKPLACE:  
[www.boxo.tools/app](http://www.boxo.tools/app)**

OSM Configurator

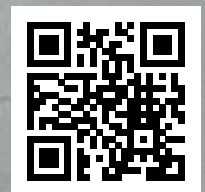



# BOXO OSM accessories

## Drawer divider 127, 260 or 395 mm

DD009A-14 / DD009A-15 / DD009A-16

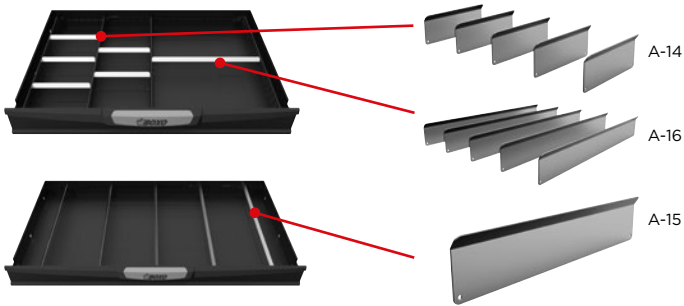

€ 10.00	<del>€ 11.85</del>	127 mm, 5 pc	DD009A-14
€ 3.95	<del>€ 4.50</del>	260 mm, 1 pc	DD009A-15
€ 13.75	<del>€ 16.15</del>	395 mm, 5 pc	DD009A-16

Starting from

**€ 3.95**

## Metal partition for drawer divider, 2 pc

DD009-A10

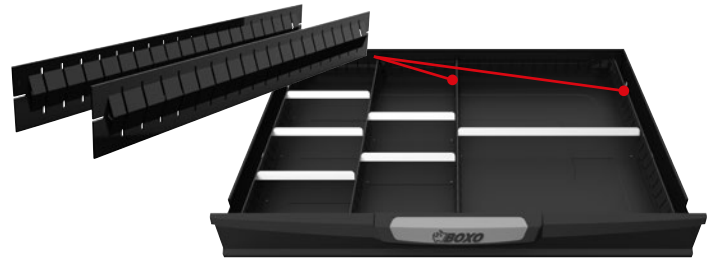

To combine with dividers DD009A-14/15/16



DD009-A10

**€ 19.25**

~~€ 22.50~~

## Document holder

MAA021

340x62x180 mm  
(WxDxH)

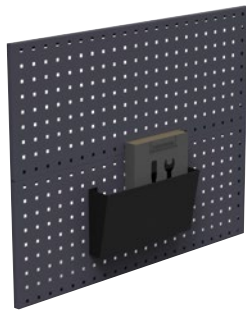

MAA021

**€ 23.25**

~~€ 27.25~~

## Magnetic glove box holder

MGH-A



MGH-A

**€ 27.75**

~~€ 32.50~~

## Impact wrench holder

MAA011A

Ø 70 mm  
115x115 mm



MAA011A

**€ 19.25**

~~€ 22.50~~

## Impact socket holder

MAA034

- 150x30x50 mm (WxDxH)
- Impact sockets not included



MAA034

**€ 16.50**

~~€ 19.15~~

## Shelf

MSN007-2

830x24x80 mm  
(WxDxH)

Max. 20 kg



MSN007-2

**€ 47.25**

~~€ 55.50~~

## Universal box rack for 81-bin series

MSN008-2

850 mm

For small storage bins  
81-BIN03  
81-BIN04  
81-BIN05



MSN008-2

**€ 56.75**

~~€ 66.75~~

### Empty trays with 2, 4, 8 or 12 compartments, 568x395 mm

BXP000-SERIE

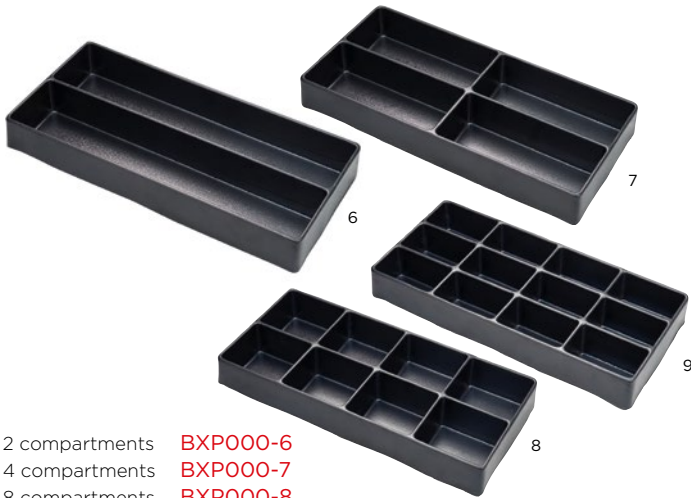

- 2 compartments BXP000-6
- 4 compartments BXP000-7
- 8 compartments BXP000-8
- 12 compartments BXP000-9

Starting from

**€ 6.50**

~~€ 7.65~~ Per piece

### Bins

82-BIN-SERIE

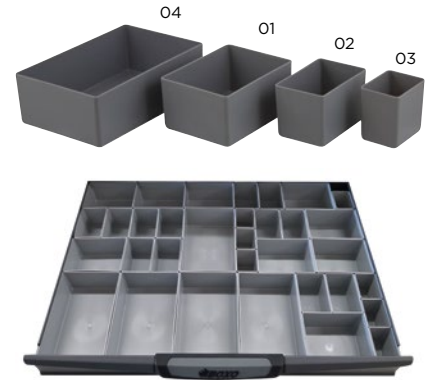

- € 1.59 ~~€ 1.85~~ 106x80x54 mm, grey 82-BIN01
- € 1.39 ~~€ 1.60~~ 80x53x54 mm, grey 82-BIN02
- € 1.19 ~~€ 1.35~~ 53x40x54 mm, grey 82-BIN03
- € 2.25 ~~€ 2.65~~ 160x106x54 mm, grey 82-BIN04

Starting from

**€ 1.19**

### Empty foam tray with 1 or 3 compartments

BX000-1 / BX000-3

Size 189x398 mm



BX000-1 / BX000-3

**€ 12.50**

~~€ 14.75~~

### Empty trays with 3, 4 or 10 compartments

BXP000-1 / BXP000-2 / BXP000-3

Dimensions 568x395 mm



- € 11.75 ~~€ 13.75~~ 4 compartments BXP000-1
- € 11.75 ~~€ 13.75~~ 3 compartments BXP000-2
- € 11.75 ~~€ 13.75~~ 10 compartments BXP000-3

**€ 11.75**

### Double pen tool hanger

P-TDH-20 / P-TDH-40



- € 3.75 50 mm P-TDH-20
- € 3.95 95 mm P-TDH-40

Starting from

**€ 3.75**

### Single pen tool hanger

P-TSH-20 / P-TSH-40



- € 3.50 50 mm P-TSH-20
- € 3.75 95 mm P-TSH-40

Starting from

**€ 3.50**

# Powerhand tools

**POWERHAND**  
TOOLS BY SERENCO

Our own range of Powerhand power tools are a well-established, high quality range of cordless Li-Ion tools. Our portfolio is mainly aimed at the automotive sector and includes a comprehensive range of impact wrenches, ratchets, caulking guns and more. All products are supplied with a 12 month warranty with full in-house after sales service. The range now, more than ever, lives up to its slogan 'Power for Professionals'.

## Battery powered torque multiplier - 1,500 Nm

PH-1500-24V

**BEST BUY**



- Lightweight, 21.6 V, 6 Ah
- 4 Torque selections for tightening 450 Nm, 650 Nm, 800 Nm, 1,500 Nm
- Less wear of impact sockets
- 80 dB Silent in use (compared to an air impact wrench)
- Battery indicator,
- 360 degree rotating arm
- Battery protection bracket
- 1" anvil
- Incl. 2 batteries, 3 sockets and 3 deep sockets: 30, 32, 33 mm
- Weight: 12 kg

PH-1500-24V

**€ 1,249.00**

~~€ 1,299.00~~

YouTube





## Cordless caulking gun Li-Ion, 10.8 V

T65805238-K



- Cordless caulking gun for both sausage bag (400 ml) and cartridge (310 ml) applications
- 2 Ah, 10.8 V
- Variable speed control
- Auto stop function
- 1 Hour intelligent charger
- Patented dripless mechanism
- Patented rapid plunger release mechanism
- 600 ml on request
- Force: 450 kgf
- Weight: 2.45 kg

2 Ah

T65805238-K

**€ 349.00**

~~€ 362.00~~

## Torque multiplier, 5,200 Nm

PH-3510

- Compact, robust and designed for the professional
- The Powerhand Torque Multiplier will loosen the tightest wheel nuts on trucks, agricultural machines and other heavy vehicles
- Maintenance free, 32 mm and 33 mm impact sockets included
- Heavy duty storage box



PH-3510

**€ 114.00**

~~€ 125.00~~

## Cordless grease gun, Li-Ion, 18 V

T75501158-K

**BEST BUY**

- Pressure safety valve in case of a blocked lubricant line
- 4 Ah, 18 V
- Charging time: 1 hour
- Suitable for bulk or grease cartridges
- Weight: 3.82 kg



T75501158-K

**€ 419.00**

~~€ 428.00~~



The right light for every situation. The real professional knows that good lighting is indispensable for every operation. The extensive Powerhand range is of high quality and competitively priced. Value for money. And for that reason dominant presence on the European market for years. The Powerhand range of work lamps has been specially designed for the professional user in the workshop or on the move. All Powerhand lights come with a 12-month guarantee.

## Pen light, with magnetic pocket clip

SIN-100.2008

- Brightness: 130 Lumen
- Brightness spot: 50 Lumen
- IP20
- IK07
- Colour temperature: 5,700 K
- Size: 20x15x160 mm
- Lightweight (0.044 kg)
- Incl. 2x AAA battery
- Ultra slim design
- Pocket clip with magnet
- Shock resistant ABS housing
- SMD

SIN-100.2008

€ 10.75



## Rechargeable pen light

SIN-100.2009

- Brightness: 150 Lumen
- Brightness spot: 70 Lumen
- 3.7 V 0.6 Ah Li-Ion battery provides 2.5 ~ 4 hours constant light output
- Charging time: 2 hours
- IP20
- IK07
- Colour temperature: 5,700 K
- Size: 20x15x160 mm
- Lightweight (0.039 kg)
- USB-C cable
- Ultra slim design
- Pocket clip with magnet
- Shock resistant ABS housing
- Charge indicator
- SMD

SIN-100.2009

€ 19.25



## Rechargeable inspection lamp

SIN-100.2150-B / SIN-100.2150-R

- Brightness: 100 - 300 Lumen
- Brightness spot: 80 Lumen
- 3.7 V 1.1 Ah Li-Ion battery provides 3 - 6 hours constant light output
- Charging time: 3 hours
- IP54
- IK07
- Colour temperature: 6,500 K
- Size: 300x26.5x20.5 mm
- Weight: 0.08 kg
- Slim and durable ABS housing with pocket clip and magnet
- 180° forward/ backwards swivel
- Charge indicator
- USB-C cable
- Easy to carry
- 3 integrated magnets
- COB + SMD



SIN-100.2150-B / SIN-100.2150-R

€ 37.50

## USB-charger EU, 5 V 1 A

SIN-100.1001A

- Suitable for Powerhand lights



SIN-100.1001A

€ 6.50

## USB-charger EU, 5 V 2 A

SIN-100.1002A

- Suitable for Powerhand lights



SIN-100.1002A

€ 10.75

## Multifunctional rechargeable induction work lamp

SIN-100.2035 (BORY)

- Brightness: 60 - 600 Lumen dimmable
- Brightness spot: 100 Lumen
- 3.7 V 2.6 Ah Li-Ion battery provides 2.5 - 12 hours constant light output
- Charging time: 3.5 hours
- IP42
- IK09
- Colour temperature: 5,600 K
- Size: 38x29x310 mm
- Weight: 0.20 kg
- Broad 90° light spread
- 3 integrated magnets and 180° swivel base
- Charge via USB-C cable from PC or mobile phone charger
- No hassle charging/connecting
- Charge indicator
- Including USB-C cable
- Shock resistant
- ABS housing
- 360° integrated swivel hook
- COB + SMD

SIN-100.2035 (BORY)

€ 56.00



SIN-100.2035 -B -O -R -Y

## Set of two multifunctional and rechargeable lamps, including magnetic duo pad

SIN-100.2035P2

- Brightness: 60 - 600 Lumen dimmable
- Brightness spot: 100 Lumen
- 3.7 V 2.6 Ah Li-Ion battery provides 2.5 - 12 hours constant light output
- Charging time: 3.5 hours
- IP42
- IK09
- Colour temperature: 5,600 K
- Broad 90° light spread
- 3 Internally mounted magnets and 180° swivel base
- Robust, shock resistant ABS housing
- Replaceable top mounted nylon hook
- Charge indicator LEDs
- Charge via the latest generation wireless charging pad (duo)
- USB-C cable
- Charger 2A
- Ready 2 use

Spot 150 Lumen



SIN-100.2035P2

€ 161.25



YouTube

## Magnetic induction double charging pad

SIN-100.2035-6

- Double pad
- Weight: 0.26 kg
- Acceptable charge 1 A/2 A



SIN-100.2035-6

€ 38.50

## Magnetic induction single charging pad

SIN-100.2035-4

- Single
- Weight: 0.24 kg
- Acceptable charge 1 A/ 2 A



SIN-100.2035-4

€ 30.95

## Rechargeable work lamp

SIN-100.2026 (BORY)

- Brightness: 350 Lumen
- Brightness spot: 100 Lumen
- 3.7 V 2.2 Ah Li-Ion battery provides 3.5 and 7 hours constant light output
- Charging time: 5 hours
- IP20
- IK04
- Colour temperature: 5,700 K
- Size: 55x45x248 mm
- Weight: 0.29 kg
- 2x 360° integrated swivel hook
- 180° forward/ backwards swivel
- 3 integrated magnets
- Charge indicator
- Micro USB cable
- SMD

SIN-100.2026 (BORY)

€ 37.95



SIN-100.2026 SIN-100.2026-B SIN-100.2026-O SIN-100.2026-R SIN-100.2026-Y

## Rechargeable slim work lamp

SIN-100.1070

- Brightness: 60 ~ 600 Lumen
- Brightness spot: 120 Lumen
- 3.7 V 2.6 Ah Li-Ion battery provides 2 ~ 16 and 10 hours constant light output
- Charging time: 4 hours
- IP45
- IK07
- Colour temperature: 6,500 K
- Size: 384x40x45 mm
- Weight: 0.30 kg
- Robust, shock resistant housing
- Slim design
- Broad 120° light spread
- Can be rotated 360° with a 42° tilt
- 210° integrated swivel hook
- Rotating dimmer switch
- Ball joint magnetic base
- Battery indicator
- USB-C cable
- COB + SMD



SIN-100.1070

€ 52.50

## Rechargeable multi-functional work lamp

SIN-100.1035

- Brightness: 400 Lumen
- Brightness spot: 100 lumen
- 3.6 V 2.6 Ah Li-Ion battery provides 3 hours constant light output
- Charging time: 5 hours
- IP42
- IK04
- Colour temperature: 5,700 K
- Size: 283x36x25 mm
- Weight: 0.17 kg
- Robust, shock resistant ABS housing
- Broad 90° light spread
- 180° forward/ backwards swivel
- 360° integrated swivel hook
- Strong magnet: 38 N
- Battery indicator
- Dockingstation
- COB + SMD



SIN-100.1035

€ 57.00

## Rechargeable work lamp with laser pointer

SIN-100.1045

- Brightness: 200 Lumen
- Brightness spot: 80 Lumen
- 3.7 V 1.1 Ah Li-Ion battery provides 3.5 hours constant light output
- Charging time: 2.5 hours
- IP54
- IK07
- Colour temperature: 6,500 K
- Size: 160x51x33 mm
- Weight: 0.18 kg
- Laser pointer: Klasse II
- COB + CREE



SIN-100.1045

€ 44.50



## Rechargeable aluminium flashlight

SIN-100.2030

- Brightness: 200/800 lumen and strobe
- 3.7 V 2.6 Ah Li-Ion battery provides 3 hours constant light output
- Charging time: 4 ~ 5 hours
- IP54
- IK07
- Colour temperature: 6,250 K
- Size: ø37xø31.8x155 mm
- Weight: 0.163 kg
- Professional rechargeable flashlight with CREE technology
- Cordless design improves safety, convenience and flexibility
- Lamp use is not affected by cold temperatures
- Robust, shock resistant aluminium housing
- Strobe function
- Focus function
- Powerbank function
- Strong magnet: 30 N
- Micro USB cable
- CREE



SIN-100.2030

€ 59.90

## Rechargeable UV work lamp

SIN-100.1030

- UV light: 390 - 405 Nm
- 3.7 V 2.6 Ah Li-Ion battery provides 4.5 hours constant light output
- Charging time: 4 hours
- IP65
- IK07
- Size: 190x56x29 mm
- Weight: 0.31 kg
- Strong ABS housing
- Magnet and pocket clip
- Hanging hook
- Charge indicator
- USB-charging cradle + charger
- SMD

Ideal for - UV inspection  
- Coolant leakage  
- Cracks in metal/construction  
- Dry UV paint

SIN-100.1030

€ 55.00



## Rechargeable work lamp

SIN-100.2040

- Brightness: 110/220/500 Lumen
- Brightness spot: 150 Lumen
- 3.7 V 2.6 Ah Li-Ion battery provides 1.5 - 7 hours constant light output
- Charging time: 4 hours
- IP65
- IK07
- Colour temperature: 4,500 K
- Size: 59x41.5x230 mm
- Weight: 0.38 kg
- 50° light spread
- Robust, shock resistant housing
- 360° integrated swivel hook
- 180° forward/backward swivel
- True view
- Battery indicator
- Micro USB cable + charger
- COB + SMD

Spot 150 Lumen



SIN-100.2040

€ 49.90

**BEST BUY**



## Work lamp accessory 360° foldable slimlight SIN-100.1067

- Brightness: 50%: 175 lumen  
100%: 350 lumen
- IP54
- IK07
- Colour temperature: 6,000 K
- Slimlight with 360° swivel
- COB



SIN-100.1067

€ 21.50

## Rechargeable 3 in 1 multi-functional work lamp set SIN-100.1060

- Set includes: slimlight (brightness: 175/350 Lumen), flexlight (brightness: 100/200 Lumen) and flashlight (brightness: 140/280 Lumen)
- 3.7 V 2.2 Ah Li-Ion battery provides 2.5 - 8 hours constant light output
- Charging time: 3 - 4 hours
- IP54
- IK07
- Colour temperature: 5,900 K
- Made from high-quality anodized aluminium for reduced weight and extra strength
- Strong magnet in the base
- Power indicator switch
- Car charger
- USB-C cable
- Charger 1 A
- SMD



SIN-100.1060

€ 61.50



SIN-100.1060

## Rechargeable flood light

SIN-100.2085

- Brightness: 1,000 or 2,000 Lumen
- 3.7 V 8 Ah Li-Ion battery provides 2.5 - 6 hours constant light output
- Charging time: 6 hours
- IP65
- IK08
- Colour temperature: 6,000 K
- Size: 208x204x52 mm
- Weight: 0.67 kg
- 110 - 120° swivel base
- M8 Hole size for connecting to crossbar or tripod
- Non-blinding work lamp
- Robust and shock resistant
- ABS housing
- Battery indicator for easy monitoring
- USB-C cable
- Powerbank function
- SMD



SIN-100.2085

€ 64.00



## Crossbar for connecting to tripod, can hold 3 flood lights

SIN-100.2135

- 2 sided
- With different fixing positions



SIN-100.2135

€ 24.50

## Tripod

SIN-100.2130

- For use with SIN-100.1075, SIN-100.2175 and SIN-100.2085
- Easy to use
- Height: 110 - 200 cm



SIN-100.2130

€ 53.50

## Universal magnetic workshop lamp

SIN-100.2100



- Brightness: 700 Lumen
- IP30
- IK06
- Colour temperature: 6,100 K
- Size: 50x3 cm
- Weight: 0.27 kg
- 120° light spread
- Aluminium design
- Non-blinding work lamp
- Ideal for: workshop, lifting bay, vans, production lines
- Strong integrated magnets
- SMD

SIN-100.2100

€ 32.00

## Extention cable for universal workshop lighting

SIN-100.2115



- Length: 50 cm

SIN-100.2115

€ 6.75

## Power supply for universal workshop lighting

SIN-100.2105



- 230V
- For SIN-100.2100

SIN-100.2105

€ 20.75

## Remote control for universal workshop lighting

SIN-100.2110



- For SIN-100.2100

SIN-100.2110

€ 37.00

## Rechargeable under bonnet lamp

SIN-100.1019

- Brightness: 700 or 1,500 Lumen
- 3.7 V, 4.4 Ah Li-Ion battery provides 2.5 - 5.5 hours constant light output
- Charging time: 2.5 hours
- IP65
- IK08
- Colour temperature: 6,100 K
- Size: 1153x67x86 mm
- Weight: 0.805 kg
- Dual 360° soft padded swivel hooks for flexible light positioning
- Extendable for application's between 115 up to 180 cm
- Can be used while charging
- Broad 120° light spread
- Low power consumption
- Low heat emission
- Battery indicator
- SMD

360° swivel light output

- Hybrid use -

115 - 180 cm

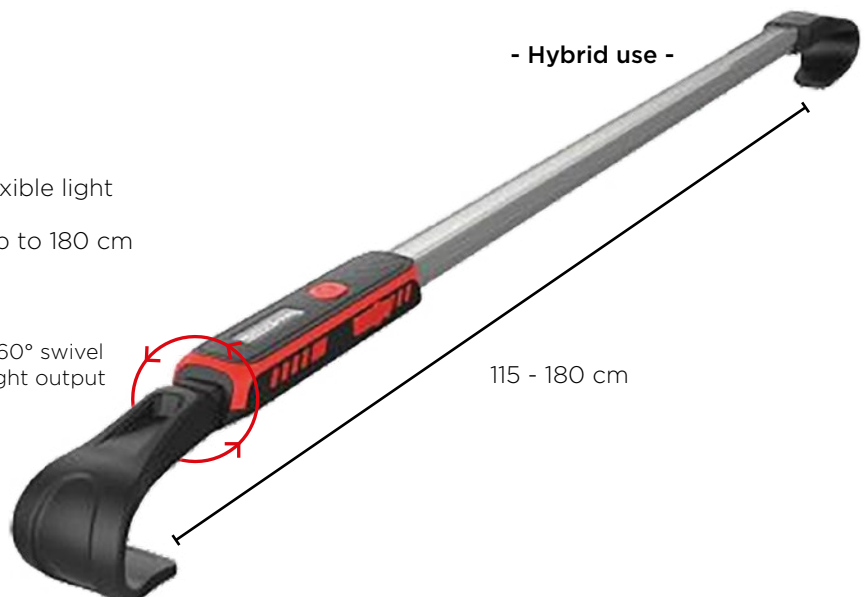

SIN-100.1019

€ 114.00

## Rechargeable hands-free neck lamp

SIN-100.2165

- Brightness: 15 ~ 300 Lumen
- 3.7 V 2.0 Ah Li-Ion battery provides 5 ~ 10 hours constant light output
- Charging time: 4 hours
- IP42
- IK07
- Colour temperature: 6,500K
- Size: 185x145x45 mm
- Weight: 0.23 kg
- Hands free
- Strong integrated magnets
- SMD



SIN-100.2165

€ 38.50

## Head lamp with sensor

SIN-100.2010

- Brightness: 200 Lumen
- 3.7 V 2.2 Ah Li-Ion battery provides 4 hours constant light output
- Charging time: 5 hours
- IP54
- IK07
- Colour temperature: 6,000K
- Size: 77x30x40 mm
- Weight: 0.06 kg
- With motion sensor - allows hands to operate the light
- Robust, shock resistant housing
- Adjustable head strap
- Adjustable lamp tilts 180°
- Wide beam distribution lens
- Strobe function
- COB



SIN-100.2010

€ 26.50



## Rechargeable flood light

SIN-100.1075

- Brightness: 500 or 1,100 Lumen
- 3.7 V 4.4 Ah Li-Ion battery provides 3 ~ 6 hours constant light output
- Charging time: 4.5 hours
- IP68
- IK09
- Colour temperature: 5,700K
- Size: 150x101x42 mm
- Weight: 0.405 kg
- Integrated magnets, 180° swivel base
- M8 hole to support with tripod
- Shock resistant ABS housing
- Robust
- USB-C cable + charger
- Battery indicator
- COB



SIN-100.1075

€ 74.95

## Rechargeable mini flood light

SIN-100.2175

- Brightness: 300/600/900/1,500 Lumen
- 3.7 V 8 Ah Li-Ion battery provides 3 ~ 12 hours constant light output
- Charging time: 6 hours
- IP54
- IK07
- Colour temperature: 2,700/3,500/4,500/6,500 K adjustable
- Size: 128x99.5x46 mm
- Weight: 0.483 kg
- 4 brightness settings
- Strong integrated magnets
- Powerbank function
- 360° integrated swivel hooks
- M8 hole to support with tripod
- COB



SIN-100.2175

€ 74.50



# Bootgun

This ingenious air operated tool opens up flexible CV boots effortlessly and evenly allowing simple insertion onto the shaft without the need to dismantle the joint. It totally eliminates the need for lubrication and the struggling involved with the manual cone method, saving you both time and money! The accompanying range of high quality, flexible neoprene rubber boots with resistance to ozone, oil, water, grit, abrasion and temperature extremes (-40° to 115°C) have been designed specifically for use with the Bootgun. Bootgun products are fabricated in the UK.

YouTube



## Bootgun PRO

BG-211

NEW

- New ergonomic shape, easier to operate
- Suitable for universal flexible neoprene shaft sleeves 15 - 130 mm
- Can be locked at any intermediate position
- Ideal for 4x4's EV's
- Can be used without air hose
- Belt hook/suspension hook
- When laid down, it does not roll away Special air inlet/outlet, Internal air coupling, (less chance of breaking off)
- Suitable for EV vehicles (EV CV boots wear out within +/- 1.5 years)
- Weight: 2.2 kg
- With 60-month warranty



BG-211

€ 179.00

## Bootgun

BG-111

- Suitable for universal flexible neoprene shaft sleeves 15 - 115 mm
- Can be locked at any intermediate position
- Working pressure 4 - 7 bar
- Max pressure 8 bar
- Connection: 1/4"
- Weight: 2.0 kg
- With 36-month warranty

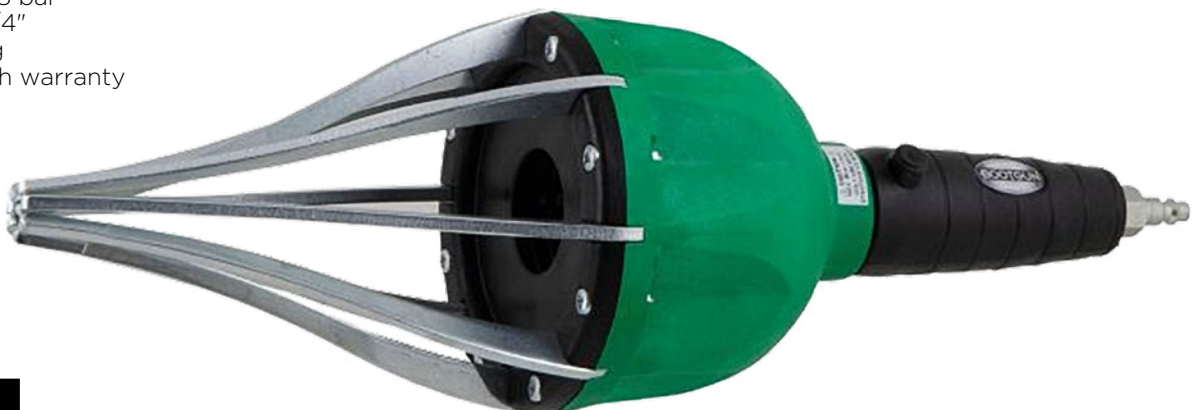

BG-111

€ 112.00

# Tyre Seals

Tyre Seals repair kits have been specifically designed to enable puncture repairs whilst the wheel remains on the vehicle. With both string and mushroom type plug repair kits in the programme, Tyre Seals is a puncture repair system that is suitable for both passenger cars and trucks. Tyre Seals have a number of standard approvals but as on vehicle puncture repair regulations vary in different countries the user should always check the local regulations before use.

## Tyre repair set for passenger cars

PU-115990



PU-115990

€ 49.00

~~€ 53.50~~

- For 60 repairs
- Standard with high quality, USA made strings

Contents:

- 1 Rasp
- 1 Open eye needle (short)
- 1 Lube/cleaner
- 1 Knife
- Weight: 0.78 kg

## Tyre repair set for trucks

PU-115991



PU-115991

€ 49.00

~~€ 53.50~~

- For 30 repairs
- Standard with high quality, USA made strings

Contents:

- 1 Rasp
- 1 Open eye needle (long)
- 1 Lube/cleaner
- 1 Knife
- Weight: 0.78 kg

**BEST BUY**

## Tyre repairset for cars and vans, 'Mushroom'

PU-116000



YouTube



PU-116000

€ 124.50

~~€ 141.00~~

Mushroom style inserts are designed to "fill the injury" in passenger or vans, radial or bias-ply tyres. These mushroom ensures repair. The plug kit makes repairing tyres easy and convenient. No great force is needed to insert the plug into the injury, the metal probe of the plug gun slides smoothly into place, the plug can be applied by squeezing the handle on the plug gun a few times. Plugs available in 8 mm which will fill up holes up to 6 mm.

Contents:

- Plug gun
- Plier
- Rasp
- Nozzle 6.4 mm
- 8 mm Mushroomplugs seal up to 6 mm holes (2x 25 pc)
- Scissor
- Sillicone lubricant
- Knife

# Projecta Intelli-Start Jumpstarters

Never get caught out with a flat battery again – no matter where you are! The expanding range of Intelli-Start Jump Starters are compact yet powerful enough to keep passenger cars, boats, motorcycles, ride-on mowers and recreational vehicles moving. These super-smart jump starters use a revolutionary LiFePO<sub>4</sub> battery and patented **Rapid Recharge Technology** to recharge themselves after use (40 sec.) – so they're always ready when you need them.

Whether you've been camping in the middle of nowhere or you're starting a problem car in the workshop, Intelli-Start Jump Starters ensure you'll never let a flat battery ruin your day again!

## IS920 Jumpstarter & Power bank, 900 A, 12 V

IS920

NEW



- Jumpstarter for petrol engines up to 6 L
- 240 A clamp power and 900 A peak power
- LED work light
- USB powerbank and storage bag
- Including Rapid Recharge Technology:  
After the engine is started, leave the IS920 connected for 40 seconds and the unit will fully replenish all the energy for the next jumpstart.
- Weight 610 gr
- Pouch
- Spark free clamps
- LifePO<sub>4</sub> lasts 4 times longer
- Compact and rugged



IS920

€ 139.00

## IS1220 Jumpstarter & Power bank, 1200 A, 12 V

IS1220

NEW



- Jumpstarter for petrol engines up to 7 L and diesel engines up to 4.5 L
- 400 A clamp power and 1,200 A peak power
- With LED work light
- USB powerbank and storage bag
- Including Rapid Recharge Technology:  
After the engine is started, leave the IS1220 connected for 40 seconds and the unit will fully replenish all the energy for the next jumpstart
- Weight 800 gr
- Pouch
- Spark free clamps
- LifePO<sub>4</sub> lasts 4 times longer
- Compact and rugged



IS1220

€ 184.00



Power-Start is manufactured in the UK and designed specifically for the professional user, the Power-Start high rate jump start pack is suitable for starting most 12 V and 24 V engines - automotive, air, marine and rail. With safety in mind, each starter pack incorporates many safety features. Reverse polarity warning reduces the risk of wrongful connection whilst spike protection circuits reduce the risk of damage to the vehicle on-board electronic systems.

The voltage-free main switch ensures a safe connection and also prevents unintentional short circuits. Manufactured by a NAVO-certified company, Power-Start is the logical choice for the professional. Serenco has an in-house after-sales service for all Power-Start boosters.

YouTube



## Jumpstarter 700E, 12 V 700 A with long cable PS-700EL

- Most used starting solution for all 12 V vehicles
- Audible reverse polarity warning
- On/Off isolator switches
- Spike protection,
- Featuring high quality battery and charger
- Recyclable polyethylene casing
- Full in-house after-sales service
- Fully insulated cable clamps
- Welding grade cables 175 cm - 25 mm<sup>2</sup> full copper
- 12 V car charger
- Clamp power 700 A
- Peak power 1,600 A



PS-700EL

€ 399.00

~~€ 439.00~~

## Jumpstarter 750LIL, 750 A Li-Ion, 12 V PS-750LIL

- Voltage: 12 V
- Battery: 8 Ah
- Full in-house after sales service
- Cranking Amps: 750 A
- Peak Amps: 1,000 A
- Cable: 25 mm<sup>2</sup>/1.75 m
- Light weight 4.75 kg



PS-750LIL

€ 449.00

~~€ 495.00~~

## Jumpstarter 1224HD-E, 1,100 A for 12 V and 24 V PS-1224HD-E

- Most used starting solution for all 12 and 24 V HD vehicles (touring car, earth moving machines)
- On/Off isolator switches
- Spike protection
- Full in-house after-sales service
- Recyclable polyethylene casings
- Fully insulated cable clamps
- Welding grade cables
- 12 V car charger
- Clamp power:
  - 12 V 1,100 A
  - 24 V 1,100 A
- Peak power:
  - 12 V 3,500 A
  - 24 V 1,600 A

**BEST BUY**



PS-1224HD-E

€ 1,469.00

~~€ 1,619.00~~

# POWERSTART

BOOSTERS BY SERENCO

## Jumpstarter 1224E, 12 V 1200 A and 24 V 700 A

PS-1224E

- Most used starting solution for all 12 and 24 V vehicles
- On/Off isolator switches
- Spike protection
- Full in-house after sales service
- Clamp power:
  - 12 V 1,200 A
  - 24 V 1,200 A
- Peak power:
  - 12 V 3,500 A
  - 24 V 1,600 A



PS-1224E

€ 769.00

~~€ 849.00~~

## Jumpstarter 800E, 12 V 800 A

PS-800E

- Audible reverse polarity warning
- On/Off isolator switches
- Spike protection
- Featuring high quality battery and charger
- Recyclable polyethylene casings
- Full in-house after-sales service
- Fully insulated cable clamps
- Welding grade cables
- Clamp power: 12 V 800 A
- Peak power: 12 V 2,400 A



PS-800E

€ 649.00

~~€ 719.00~~

BEST BUY

## Trolley for Power-Start jumpstarters

PS-TROLLEYV2

- With new improved wheels



PS-TROLLEYV2

€ 129.00

~~€ 137.50~~

## OBDII Cable for Power-Start

PS-OBDDII

- OBI II Cable for 12 V
- 54 cm
- Ideal for battery exchange service



PS-OBDDII

€ 22.50

~~€ 24.75~~



Power Probe products are state of the art automotive test and diagnostic equipment. Every Power Probe product is thoroughly tested to ensure it meets the highest standards of quality and reliability before it leaves the factory. Power Probe originally started with the Power Probe 3, but now offers an extensive range of quality products.

## Power Probe 3

PP3CSRED / PP3CSCARB

- Probe - Connect - Detect!
- Continuity tester
- Power cable
- Voltmeter
- +/- Voltage indicator
- Audible feature
- Bad ground indicator
- Peak to peak mode
- Heavy-duty 4 mm keyed connectors



PP3CSRED / PP3CSCARB

€ 129.00

~~€ 151.50~~

**BEST BUY**

## Dual zone thermometer wireless

PTEMPKIT

- Measure multiple temperatures simultaneously
- Multiple readings - measure temperatures from two locations upto 5 m apart
- Add an additional probe (PP-TEMPPROBE available separately) to measure up to 3 locations
- Backlit LCD display
- Measures -23°C to 56°C



PTEMPKIT

€ 39.95

~~€ 47.25~~

## 5 V Adapter

PPT5VA

- Weight: 0.045 kg
- Canbus adapter



PPT5VA

€ 26.50

~~€ 31.00~~



**Hybrid Multimeter, CAT IV, digital**

PPDMM

- Versatile, accurate and rugged with its Large LCD Screen and Bright Backlight
- Measures AC/DC voltage, current, resistance, frequency, temperature and capacitance, data hold
- Min/Max Capture, relative measurement, and diode continuity tester
- 15 min auto shut-off function
- Rugged rubberized housing



YouTube



PPDMM

**€ 146.75**

~~€ 172.50~~

**Soldering kit, 50 W, rechargeable, Li-Ion**

PPPS50W

- Hybrid -

- 10 second fast start - ready to use
- Rechargeable lithium battery technology (2,500 mAh)
- 600 °C max soldering temperature
- 50 Watt high power output
- Fast charging time 3.5 hrs
- 45 min continuous run time
- Interchangeable solder tips
- 5 Tips
- Lead free soldering



Check our website for all specific details



PPPS50W

**€ 109.00**

~~€ 129.95~~

**Break out box for OBDII**

PPECB

- The CAN-Bus circuit tester is suitable for 12 & 24 V systems
- Once plugged into the cars DLC OBD port it will start to check the pins for any voltage present
- If voltage is present the respective LEDs will illuminate



YouTube



PPECB

**€ 245.00**

~~€ 289.00~~

Check our website for all specific details



**Electronic circuit tracer (short/open)**

PPECT3000

- The PPECT3000 Electrical Short and Open finder makes locating shorts and opens quicker and more accurate than ever before



YouTube



PPECT3000

**€ 195,00**

~~€ 229.00~~

Check our website for all specific details



GoJak was designed to improve vehicle movement and repositioning in workshops, showrooms and body shops but is also invaluable in car parks and to a multitude of rescue services. To overcome different axle widths, wheelbases, wheel sizes and tyre widths, every GoJak is self-loading.

GoJak's are mechanical, therefore very quick and simple to use without the obvious hazard of leaking hydraulics. This system makes lifting and moving vehicles in any direction very quick and easy saving both time and money. With 6 models available an immense range of vehicles weighing up to 3.128 kg can be 'lifted & shifted'.



## GoJak Vehicle mover 590 kg

G5211/G5211L

- Max. 590 kg per Gojak (2,360 kg per 4 units)
- Wheel sizes max. 914 mm Ø (incl. tyre)
- 2 Rollers from rust resistant plated steel
- 4 casters ANSI ICWM 2012 Certified
- 13.7 kg



G5211/G5211L

**€ 349.00**

Per piece

## GoJak Vehicle mover HD 715 kg

G6313/G6313L

- Max. 715 kg per Gojak (2,860 kg per 4 units)
- Wheel sizes max. 914 mm Ø (incl. tyre)
- 2 Rollers from rust resistant plated steel
- 4 casters ANSI ICWM 2012 Certified
- 17.5 kg



G6313/G6313L

**€ 399.00**

Per piece





**GoJak Vehicle mover HD Sportscars, 816 kg**

G6500

- Max. 816 kg per Gojak (3,264 kg per 4 units)
- Wheel sizes max. 914 mm Ø (incl. tyre)
- 4 Rollers from rust resistant plated steel
- 6 casters ANSI ICWM 2012 Certified
- 23 kg



500 mm



G6500

**€ 495.00**

**Gojak Vehicle mover HD for dual wheels, 782 kg**

G7016

- Max. 782 kg per Gojak (3,128 kg per 4 units)
- Wheel sizes max. 914 mm Ø (incl. tyre)
- 4 Rollers from rust resistant plated steel
- 4 casters ANSI ICWM 2012 Certified
- 24 kg



500 mm



G7016

**€ 495.00**

**GoJak for light airplanes, 465 kg**

G4107/G4107L

- Max. 465 kg per Gojak (1,860 kg per 4 units)
- Wheel sizes max. 812 mm Ø (incl. tyre)
- 4 Rollers from rust resistant plated steel
- 4 casters ANSI ICWM 2012 Certified
- 18.5 kg



180 mm



G4107/G4107L

**€ 509.00**

Per piece

**Gojak HD sportscar model, 575 kg**

G4520

- Max. 575 kg per Gojak (2,300 kg per 4 units)
- Wheel sizes max. 914 mm Ø (incl. tyre)
- 4 Rollers from rust resistant plated steel
- 4 Casters ANSI ICWM 2012 Certified
- 19.5 kg



500 mm



G4520

**€ 399.00**





## BEST BUY

### Rechargeable hybrid twin head flood light, including tripod

SIN-100.2185

- Brightness: 500/1,500/5,000 Lumen
- 7.4 V 4 Ah Li-Ion battery provides 1 - 5 hours constant light output
- Charging time: 6 hours
- IP54
- IK07
- Colour temperature: 4,000 or 7,000 K
- Size: 120x120x890 mm
- Max. height: 1,920 mm
- Weight: 4.5 kg
- Hydrocarbon and UV resistant
- Hybrid use
- SMD



SIN-100.2185

€ 215.00

# SERENCO

SERIOUS TOOLS SERIOUS RESULTS

The Tool Times is an edition of Serenco Nederland B.V.  
Maarssebroeksedijk 39 • 3542 DM UTRECHT • Tel. +31 (0)30 2415011 • www.serenco.nl • sales@serenco.nl

Serenco Nederland reserve the right to change any prices or specification without prior notice. Prices are excl. VAT. Images and specifications are made in good faith and are subject to change. Stock is subject to availability, products may be discontinued at any time. Valid till 30/08/2022. While stock last. Version 07-2022

DEALER